Table of Contents

E60/E61 Model Update

Subject	Page
Introduction	5
Systems Overview	6
New Control Units	6
Lane Departure Warning (TLC)	6
Gear Selector (GWS)	6
Longitudinal Dynamics Management (LDM)	6
Car Access System (CAS)	7
New Components	7
Long Range Radar/Short Range Radar	7
Rain/Light Solar Sensor	7
New Bus Systems	7
Sensor CAN	7
Diagnostics on CAN D-CAN	7
Principle of Operation	8
Car Access System 3	8
Rain/Light Solar Sensor	9
Electrochromic Interior Mirror	9
Modified Center Console Switch Cluster	12
Pop-up Menu	16
Center Console Switch Cluster Assembly	17
Electrical System	17
Performance Electronics	17
Steering Column Adjustment	17
Roller Sunblind E60	18
Buttons in the Center Console Switch Cluster	18
Trunk Push Button	18
Components	19
Exterior Lighting	19
Welcome Light	20
Daytime Driving Lights	21
Halogen Headlight	21
Bi-Xenon Headlights/Adaptive Headlights	21
Cornering Lights	22

Subject	Page
Activation Conditions	22
Deactivation Conditions	23
Rear Light Cluster	24
Automatic Driving Lights Control	26
Service Information	27
Diagnostics Connection D-CAN	27
Center Console Switch Cluster	27

BLANK
PAGE

E60/E61 Model Update

Model: E60, E61

Production: From March 2007 Production

OBJECTIVES

After completion of this module you will be able to:

- Identify the changes made to the E60 and E61 as of March 2007 production

Introduction

At the change of model year in March 2007, there will be new systems in the E60 and E61.

These systems include, for example, the lane departure warning and active cruise control with stop & go function.

With the lane departure warning, BMW is providing a new assistance system.

The lane departure warning warns the driver to counter-steer in the event of unintentional lane changing. It does this by generating a vibration in the steering wheel. The system is designed for use on B-roads, A-roads and highways.

Active cruise control with stop & go function makes it easier to drive in heavy traffic. The system supports repeated pulling away and braking in slow traffic queues.

Other model year actions include:

- Car Access System with electronic immobilizer 4
- Rain/light solar sensor with LIN bus
- Two-part center console switch cluster and pop-up menus for seat auxiliary functions
- Welcome light
- Daytime driving light with corona rings
- Adaptive headlights with turn-off light
- Direction indicator based on light emitting diodes LED and additional side-marker lamps at rear as standard equipment
- Diagnostics on CAN on body gateway module.

Systems Overview

Bus Diagram

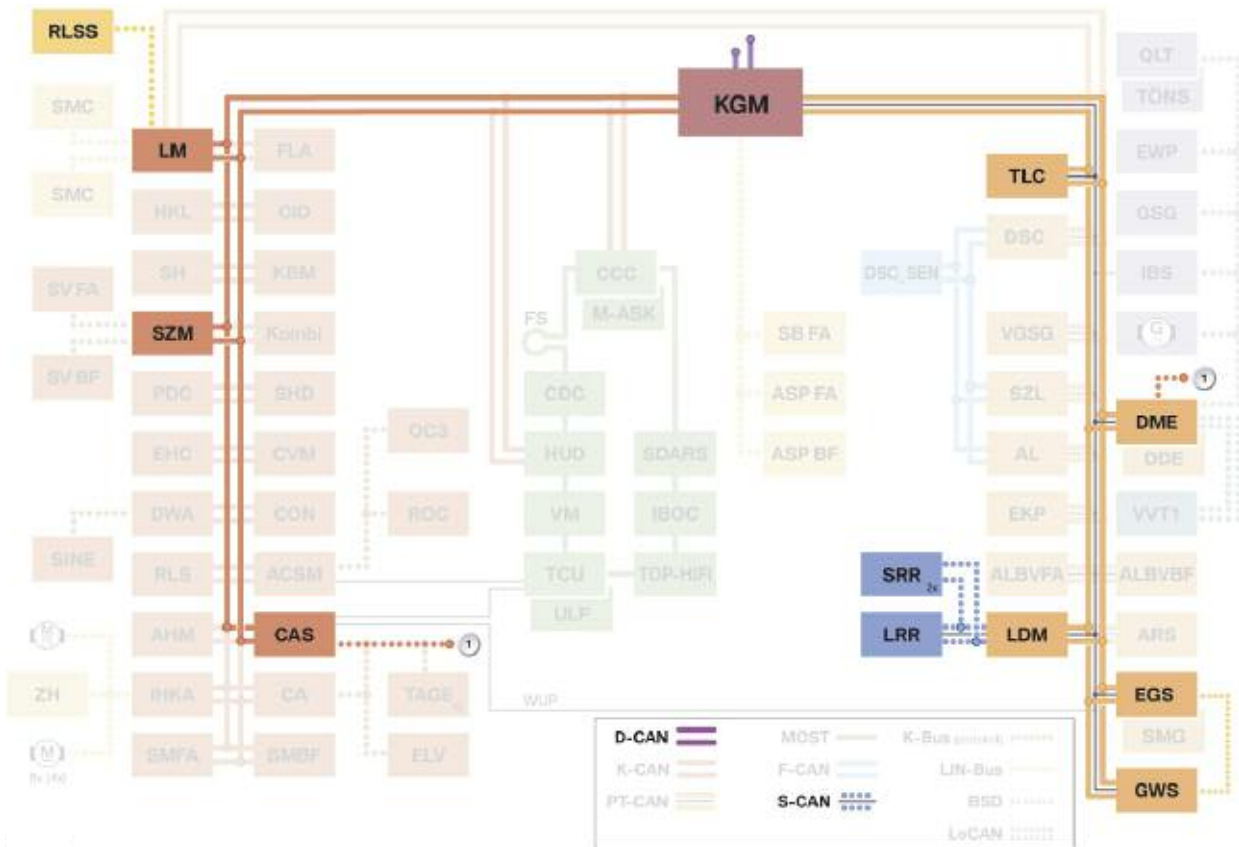

New control units are integrated in the bus system of the E60/E61. The modifications in the bus system are listed below in brief.

New Control Units

Lane Departure Warning (TLC)

The lane departure warning generates a warning when the driver accidentally changes lane. The warning should prompt the driver to counter-steer.

Gear Selector (GWS)

The control unit was first used with the E70 and is now also integrated in the E60/E61.

Longitudinal Dynamics Management (LDM)

LDM is used, amongst other things, for the "Active cruise control stop & go function" driver assistance system.

Car Access System (CAS)

The model year actions provide for the installation of the Car Access System 3 in the E60/E61.

The Car Access System 3 was first installed on the E92 and includes electronic immobilizers EWS 3 and EWS 4. Depending on the engine variant, EWS 3 or EWS 4 is operated by the Car Access System 3.

With EWS 4, the engine electronics are connected to the Car Access System 3 by a redundant data connection. The data connection is redundant to the PT-CAN and uses the K bus protocol.

New Components

Long Range Radar/Short Range Radar

Both components are for the newly installed active cruise control with stop & go function.

Center console switch cluster E60/E61 The center console switch cluster, which previously consisted of one switch bar, has been split into two switch blocks. One switch block is for the driver's side, and the other is for the front-passenger side. Between the switch blocks, there is an ashtray insert.

Rain/Light Solar Sensor

The installation of the rain/light solar sensor or rain/light sensor depends on the options. Thus, for example, only the rain/light sensor is fitted with the Japan specifications.

For vehicles with the head-up display option, it is not possible to install the rain/light solar sensor.

The above-mentioned options for the sensors result in the different connections via the LIN bus or K-CAN.

New Bus Systems

Sensor CAN

The sensor CAN S-CAN is a new bus system. The bus system is based on the PT-CAN. Therefore, the S-CAN works at the same speed as the PT-CAN and uses the PT-CAN protocol.

Diagnostics on CAN D-CAN

The body gateway module KGM now has a connection for the Diagnostics on CAN D-CAN. The connection of a D-CAN depends on the engine variant.

Principle of Operation

Car Access System 3

The Car Access System 3 CAS 3 includes the functions of Car Access System 2. A more detailed description of the Car Access System 3 is given in the following Product Information:

- "Electrical/Electronic Systems E92"
- "Car Access System E70".

Electronic immobilizer 4 EWS 4 can be used with Car Access System 3. The use of the electronic immobilizer 4 depends on the engine control system fitted. The following table specifies the engine variants and their relationship to the electronic immobilizer.

The Car Access System 3 CAS 3 includes the functions of Car Access System 2. A more detailed description of the Car Access System 3 is given in the following Product Information:

- "Electrical/Electronic Systems E92"
- "Car Access System E70".

Vehicle	Production Date (launch)	Engine	Engine Management	EWS 3	EWS 4
E60/E61	03/07	N52B30U0/N52B30OO N52B30O1/N52B30M1	MSV80		X
E60/E61	03/07	N53B25U1/N52B25O1	MSD80		X
E60/E61	03/07	N54B30U0	MSD80		X
E60/E61	03/07	N53B30U0/N53B30OO	MSD80		X
E60/E61	03/7	N62B40O1/N62B48O1	ME9.2.3	X	

Electronic immobilizer 4 EWS 4 can be used with Car Access System 3. The use of the electronic immobilizer 4 depends on the engine control system fitted. The following table specifies the engine variants and their relationship to the electronic immobilizer.

Rain/Light Solar Sensor

From 03/07 the E60/E61 will be fitted with the rain/light solar sensor. In addition, the LIN bus will be installed between the rain/light solar sensor and the light module.

The rain/light solar sensor is taken from the E70 and is adapted to the E60/E61. The light module requests the values from the rain/light solar sensor every 20 ms. In this way, it receives the request to activate or deactivate the driving light, for example.

Requests received by the light module from the solar sensor or rain sensor, are converted into K-CAN format. The light module sends the sensor signals via the K-CAN.

In this way, the body basic module receives the requests for automatic wiping and the air conditioning system receives requests for air distribution in the vehicle.

The rain/light solar sensor cannot be fitted on vehicles with the head-up display option.

Therefore, in this option, the rain/light sensor used to date is fitted. The rain/light sensor is connected via the K-CAN.

Both specifications are illustrated in the system circuit diagram on the next page.

Electrochromic Interior Mirror

The electrochromic interior mirror sends the request for lighting/dimming the outside mirror directly to the body basic module. The body basic module prompts lighting/dimming of the outside mirror.

The electrochromic interior mirror cannot be dimmed if reverse gear is engaged. Therefore, the light module sends the "RFSI" signal directly to the electrochromic interior mirror. This prevents the electrochromic interior mirror from dimming when reverse gear is engaged. This enables an optimal view to the rear via the interior mirror or the outside mirror.

System Circuit Diagram

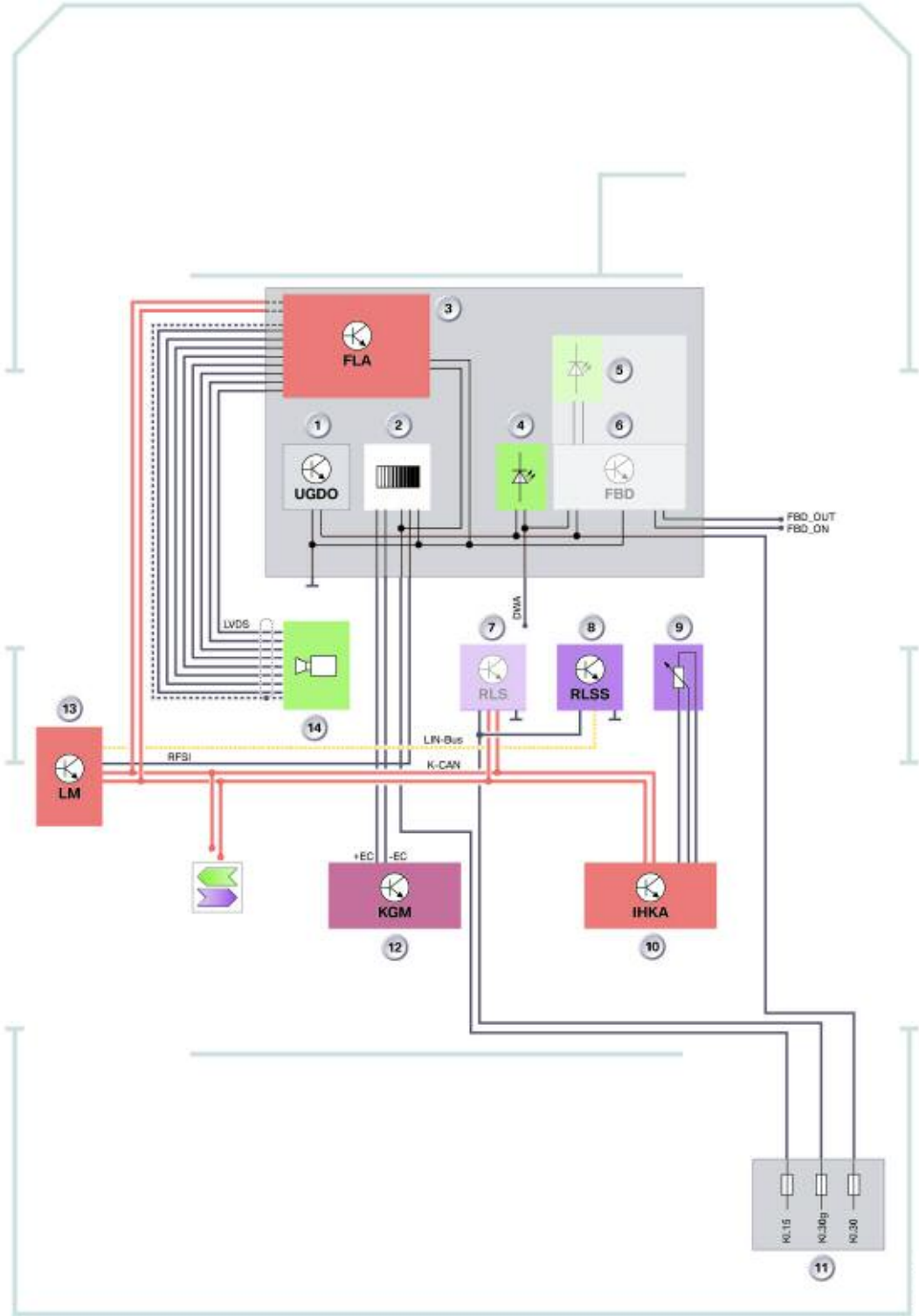

Index	Explanation
1	Universal garage-door opener UGDO
2	Electrochromic interior mirror
3	High beam assistant FLA
4	Anti-theft alarm system LED
5	Anti-theft alarm system LED
6	Remote control receiver FBD
7	Rain/light sensor RLS
8	Rain/light solar sensor RLSS
9	Mist sensor
10	Integrated heating-air conditioning control IHKA
11	Luggage compartment electrical distribution box
12	Body gateway module KGM
13	Light module LM
14	High beam assistant image sensor
K-CAN	Body CAN
LIN-bus	Local Interconnect Network bus
LVDS	Low Voltage Differential Signalling
KL 15	Terminal 15
KL 30	Terminal 30
KL 30g	Terminal 30 switched
FBD	Remote control service
FBD_OUT	Remote control service OUT
FBD_ON	Remote control service ON
+EC	+ Electrochromic interior mirror
-EC	- Electrochromic interior mirror
RFSI	Reversing light signal

Modified Center Console Switch Cluster

The center console switch cluster SZM will be replaced by a two-part SZM from 03/07. This not only changes the visual aspect, but also the functionality of the buttons.



The SZM is available in single, double or triple row versions. The version depends on the number of buttons required.

In principle, the buttons for Dynamic Traction Control (DTC) or Park Distance Control (PDC) are located in the top row.



Previous and new center console switch

If, for example, Park Distance Control was not ordered, the button for unlocking the luggage area or tailgate will be located here instead.

Center Console Switch Cluster	Version
	<p>Single-Row</p> <p>The single-row version means that only one button is integrated in the SZM on the front passenger and driver's side.</p>
	<p>Double-Row</p> <p>The double-row version means that two buttons are arranged one above the other on the front-passenger and driver's side.</p> <p>With the double-row version, the function display is shown via an LED on the button.</p> <ul style="list-style-type: none"> • Active seat width adjustment • Seat heating. 1
	<p>Triple-Row</p> <p>With the triple-row version, there are three buttons one above the other on the front passenger and driver's side.</p> <p>From the triple-row version, there is a "pop-up" menu in the Central Information Display for:</p> <ul style="list-style-type: none"> • Active seat back width adjustment • Seat air conditioning • Seat heating. 1

NOTES

PAGE

System Circuit Diagram

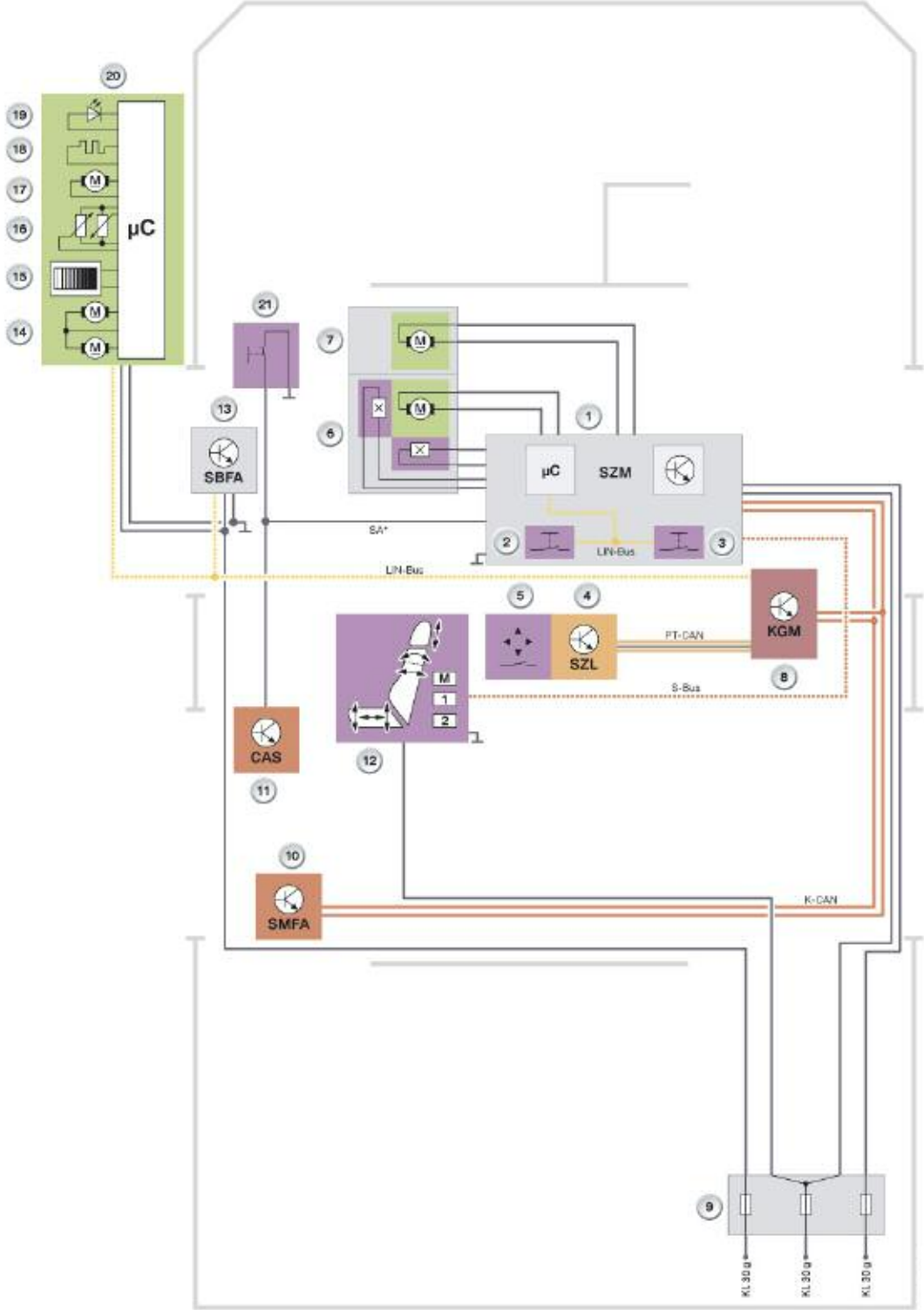

Index	Explanation
1	Center console switch cluster SZM
2	Button for driver's seat function
3	Button for front passenger seat function
4	Steering column switch cluster (SZL)
5	Steering column adjustment button
6	Driver's outside mirror
7	Mirror adjustment motors
8	Potentiometer memory position
9	Outside mirror heating
10	Mirror folding motor
11	Electrochromic outside mirror
12	Courtesy lighting
13	Boot lid push button
14	Body gateway module KGM
15	Luggage compartment electrical distribution box, left
16	Driver's seat module
17	Seat-adjustment switch
18	Car Access System CAS
K-CAN	Body CAN
PT-CAN	Powertrain CAN
LIN bus	Local Interconnect Network bus
KL 30g	Terminal 30 switched
KL 58g	Terminal 58 switched
Option*	Dependent on option

As for the triple-row version, it is only possible to display the function via the LED in the button.



This means that pressing the button (2 or 3) calls up the associated pop-up menu in the Central Information Display.

The individual activation stages of the specific function are shown in the Central Information Display.

Pop-up Menu

Depending on the option, pop-up menus can be displayed in the Central Information Display. The pop-up menus are dependent on the following auxiliary seat functions:

- Seat heating in conjunction with seat climate
- Seat heating in conjunction with active seat
- Seat heating in conjunction with seat climate and active seat
- Seat heating in conjunction with active seat back width adjustment
- Seat heating in conjunction with seat climate and active seat back width adjustment

Example of "Pop-up" Menu	Seat Function
	Seat Heating
	Seat Climate
	Active seat back width adjustment

Pressing the button for an auxiliary seat function causes this function to be activated. A pop-up menu appears in the Central Information Display. When the function is switched on, the highest setting for the activated function is shown first. By pressing the button again, you can shift through until the function is switched off or reactivated again.

The pop-up menu for the auxiliary seat functions fades to show Check Control messages for the time during which the Check Control messages are present.

It is still possible to shift through the seat function. The only indicator in this situation is the activation display via the LED on the button.

Note: If seat functions were stored before leaving the vehicle, they will still be active the next time the vehicle is started.

Center Console Switch Cluster Assembly

The center console switch cluster consists of an electrical system, performance electronics and the driver's and front-passenger side button blocks.

The performance electronics are connected via a 20-pin connector. The electrical system has a 32-pin connection. The two electrical systems communicate with each other via a 12-pin ribbon cable.

The electrical system is integrated in a 2/3 housing and the performance electronics are integrated in a 1/3 housing (module). Both modules are installed in the glove box device holder.

The electrical system, performance electronics and buttons are connected to terminal 30g.

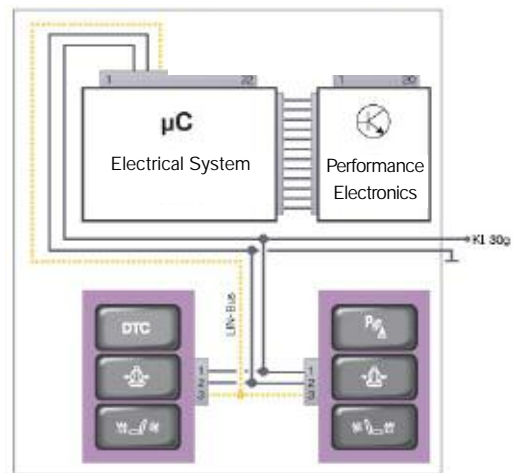

Basic Assembly of the Steering Column Switch Cluster

■ Electrical System

The LIN bus of the SZM-electrical system only connects the SZM-button blocks.

The electrical system is responsible for analyzing the information from the following bus systems:

- Body-CAN K-CAN
- Seat bus S bus based on K bus protocol
- Local Interconnect Network bus LIN bus, only for internal connection in the center console switch cluster.

■ Performance Electronics

The performance electronics control the motors for steering-column adjustment and for the roller sunblind.

■ Steering Column Adjustment

The electrical system monitors the Hall sensors for the electric steering-column adjustment. Thus, the position of the steering column can be used for the steering column memory function, based on the Hall sensor pulses.

The request to activate the motors for steering column adjustment is received by the electrical system via the K-CAN. The electrical system forwards the request to the performance electronics, which activates the motors.

Note: The buttons for the steering-column adjustment are analyzed by the steering column switch cluster. The steering column switch cluster sends the request via the PT-CAN. The body-gateway-module converts the signal to the K-CAN.

■ Roller Sunblind E60

The request to activate the roller sunblind is received via the K-CAN. The electrical system analyzes the request and the performance electronics activate the motor.

Note: The button for the roller sunblind is analyzed by the driver's switch block. The driver's switch block is connected to the body gateway module via the LIN bus. The body gateway module requests the status of the button cyclically from the driver's switch block.

In this way, the body-gateway-module receives the request to activate the roller sunblind and converts this to the K-CAN.

■ Buttons in the Center Console Switch Cluster

The buttons in the center console switch cluster are connected to the electrical system via the LIN bus. The electrical system sends the status of the buttons via the K-CAN.

In this way, the Park Distance Control can be activated or deactivated by pressing the PDC button, for example.

■ Trunk Push Button

For vehicles without optional equipment, the boot-lid push button is located on the A-pillar and is redundant in the center console switch cluster.

Components

Exterior Lighting

In 03/07, the exterior lighting of the E60/E61 will have the following function additions:

- Welcome light
- Daytime driving light with corona rings (only with bi-xenon lights)
- Turn-off light (only with bi-xenon lights)
- Side-marker light at rear, as standard
- High beam assistant option 5AC can be deactivated via the light settings menu

For these additions, not only new headlights or rear lights are required, but also a new light module. The light module contains the abovementioned functions and the connection options. The pin assignment is to be taken from the BMW diagnostics system.

The external dimensions of the headlights and rear lights remain the same. The modifications are within the headlight or tail light, such as corona ring for the daytime driving light or direction indicator based on light emitting diodes LED in the rear light.

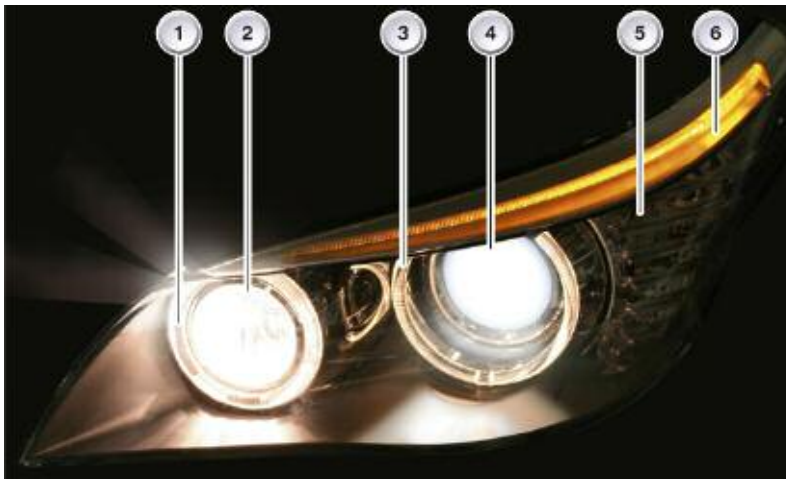

Index	Explanation
1	Parking light/daytime driving light
2	Turn-off light
3	Parking light/daytime driving light
4	Low-beam headlights/high-beam headlights
5	Direction indicator
6	Side-marker light

Welcome Light

The welcome light is activated for around 20 seconds when the vehicle is unlocked. In addition to the interior lighting, the following lights are also activated for the welcome light:



- Parking light, corona rings in parking light function
- Tail light bars, also the dimmed rear fog lights on the E60
- License plate light
- Courtesy lights
- Side-marker light
- Illumination of the instrument cluster as indicator lamp

Note: For the welcome light function, the light switch must be in the "low-beam headlights" or "automatic driving lights control" position.

The welcome light is activated as factory default. With the controller, the welcome light can be deactivated via the Central Information Display.

To do this you must select menu item:

"Settings" > "Vehicle/Tires" > "Light settings"
> "Welcome light"

Confirm the desired setting by pressing the controller.



Daytime Driving Lights

The daytime driving light is available with halogen headlights or bi-xenon headlights as well as with adaptive headlights.

Halogen Headlight

With halogen headlights, the light switch must be in the "automatic driving lights control" position. With the daytime driving light, the driving light is used.

Bi-Xenon Headlights/Adaptive Headlights

The daytime driving light with corona rings is only available in conjunction with the bi-xenon headlights and adaptive headlights options. In the daytime driving light function, the corona rings of the headlights and the tail light bars of the rear lights are activated.





The principle for generating the daytime driving light with corona rings is taken from the E92. The light in the inside chamber of the main headlight is fed into the corona rings through optical fiber cables. Only one bulb per headlight is used for feeding light to the corona rings.

For the daytime driving light function, the light switch must be in the "light OFF" or "automatic driving lights control" position. The switch position is important, as the daytime driving light cannot be activated by the light module otherwise.

The corona rings are switched on from terminal 15 ON, with the corresponding light switch position. The bulb is actuated in pulse width modulation. Pulse width modulation makes it possible to realize the daytime driving light and parking light functions.

In the event of a defect in the daytime driving light or parking light, the following information is displayed or issued:

Check Control Message	Meaning	Messages in the Central Information Display
	Left parking light/daytime driving light failed.	Left parking light/daytime driving light. Left parking light/daytime driving light failed. Have checked by nearest BMW Service.
	Right parking light/daytime driving light failed.	Right parking light/daytime driving light. Right parking light/daytime driving light failed. Have checked by nearest BMW Service.

The daytime driving light function can be activated or deactivated via the Central Information Display using the controller.

To do this, you must select the menu option "Settings" > "Vehicle/Tires" > "Light settings" > "Daytime driving light". See also the Owner's Handbook.

Note: The daytime driving light is subject to statutory and country-specific regulations. These statutory and country-specific regulations must be complied with.

Cornering Lights



The cornering lights is integrated with the xenon light option. With the turn-off light, the areas in front of and beside the vehicle can be illuminated, in addition to the adaptive headlights.

The cornering lights has been integrated in the place of the former auxiliary high-beam light in the headlight.

A special reflector geometry and positioning of the H3-bulb makes it possible for the light to be beamed to the side.

The function of the turn-off light is taken from the E92. The function of the H3-bulb is monitored by the light module.

In the event of a defect in the turn-off light, the following information is displayed or issued:

Check Control Message	Meaning	Messages in the Central Information Display
	Left cornering lights failed.	Left cornering lights light. Left cornering lights failed. Have checked by nearest BMW Service.
	Right cornering lights failed.	Right cornering lights. Right cornering lights failed. Have checked by nearest BMW Service.

To activate the cornering lights, the adaptive headlights must first be switched on via the automatic driving lights control.

The cornering lights is not activated if the hazard warning lights or one-touch direction indicator function are in operation.

The cornering lights is not activated when the high-beam headlights or headlight flasher are activated. If the high-beam headlights or headlight flasher is switched off and the switch-on conditions are fulfilled, the cornering lights are activated.

Activation Conditions

The activation conditions for forwards travel are:

- 0 mph
- Steering angle approximately 40 - 70°
- Engine Running

The activation conditions for reverse travel are:

- Reverse gear selected
- Turn-off light on both sides

Deactivation Conditions

The turn-off light is switched off if none of the switch-on conditions is met:

- Adaptive headlights OFF and
 - Direction indicator OFF or
 - Steering angle reversed or
 - Reverse gear OFF.

In vehicles with Europe specifications, the turn-off light is also switched off when the high-beam headlights or headlight flasher are activated.

In addition, the turn-off light is switched off if one of the following parameters applies:

- Road speed
- Vehicle stationary
- Time out, time or temperature-related limitation
- Dynamism, vehicle drifting

The conditions are given in the following table:

Other Switch-off Conditions		
Road Speed	Switch-on Condition	Remark
70 km/h	Steering Column	When the vehicle is in motion
Stationary	Switch-on Condition	Remark
0 mph	Steering angle	5° - 10° reduced according to switch-on condition
Time out	Condition	Remark
> 4 seconds	FRAZ on, $v = < 2$ km/h steering angle 0°	Turning at traffic lights
Temperature Model	Condition	Remark
	Steering movement and yaw rate have opposite directions	Headlight protection
Dynamism	Condition	Remark
Drifting	Steering movement and yaw rate have opposite directions	Adaptive headlights switch to straight-ahead position

Rear Light Cluster

A new feature here is the side-marker light integrated in the rear light cluster as standard on vehicles with Europe specifications.

The direction indicators and the side-marker lights are shown in LEDs (light emitting diodes).

For the additional side-marker light, four LEDs are used on the E60 and two LEDs on the E61.

For the brake light (BL), the outer and inner chamber of the rear light cluster is used. For the brake-force display (BFD) function, the rear fog light NSL chamber is used. If the rear fog light is switched on, the brake-force display is not shown. The following table shows which lights are activated, according to the function.

Function	Activated Lights
BL Normal	BK1 + BL2
BL + BFD	BL1 + BL2 + BFD
BL + NSL	BL1 + NSL

Note: When the rear fog light is ON, the inner chamber of the rear lights cluster is not used as the brake light (BL2). This is because a legally required distance of 100 mm is prescribed between the light surfaces of the brake light and the rear fog light.

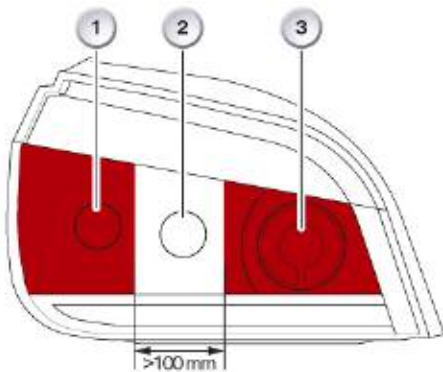

Index	Explanation
1	Exterior chamber for brake light - BL1
2	Interior chamber for brake light - BL2
3	Rear fog light NSL/brake-force display - BFD
> 100 mm	Legally required distance between light surfaces of BL/NSL must be greater than 100 mm

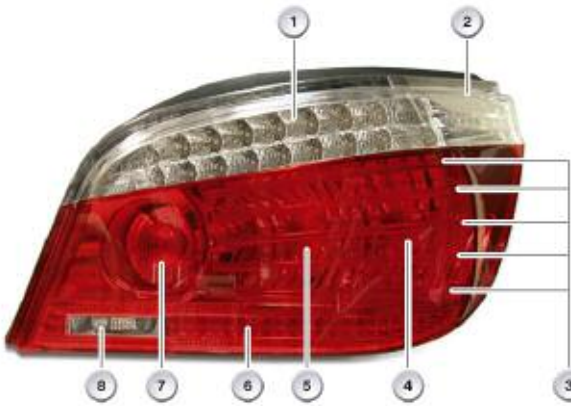

Rear Light E60

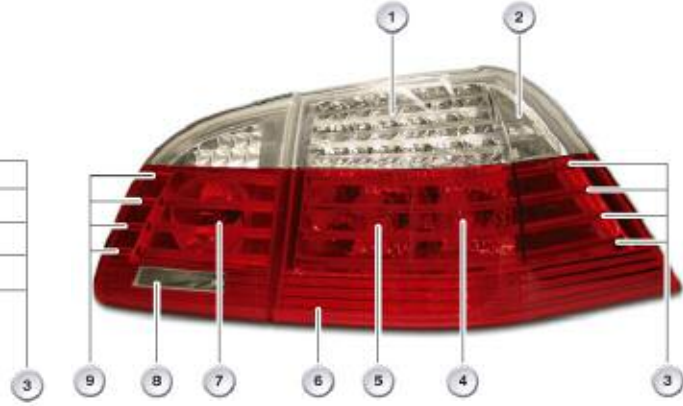

Rear Light E61

Index	Explanation
1	Direction indicator (basic LED)
2	Side-marker light (LED)
3	Tail light bars (basic LED)
4	Brake light 1
5	Brake light 2
6	Reflector
7	Brake-force display
8	Reversing light
9	Tail light bars (basic LED)

Automatic Driving Lights Control

With the model year actions, the E60 and E61 also now have a rain/light solar sensor.

The rain/light solar sensor is connected to the light module via the LIN bus.

The requests to switch the driving light on or off are received by the light module via the LIN bus. The light module requests the status of the rain/light solar sensor cyclically from the LIN bus.

The rain/light solar sensor responds to the requests from the light module.

The light module converts the signals from the rain/light solar sensor to the K-CAN and vice versa. Thus, the light module is the gateway between the LIN bus and the K-CAN

Note: In vehicles with the head-up display, lane departure warning the previous rain/light sensor is used. The rain/light sensor is connected via the K-CAN.

Service Information

Diagnostics Connection D-CAN

A new communication interface will be used for diagnostics in future.

D-CAN (Diagnostics on Controller Area Network) will replace the previous diagnostics interface world-wide. In this way, BMW has met the requirements of standard ISO 15765 (Diagnostics on CAN with KWP 2000 [Keyword Protocol 2000] or UDS [Unified Diagnostic Service]).

The D-CAN data-signalling rate is 500 kbit/s.

The background for the change-over is a new legal regulation in the USA, according to which all vehicles from model year 2008 must be fitted with a D-CAN. The transition phase began in September 2006.

The change-over to D-CAN in all ranges and model variants is planned for 3/2007 and 9/2007, depending on the type of engine installed.

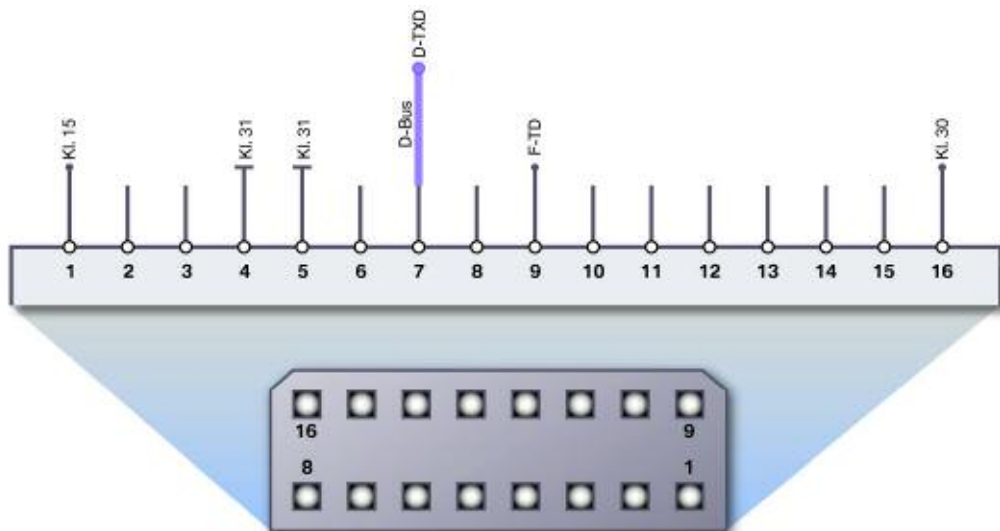

Pin Assignments E60/E61

An OBD-tool or BMW diagnostics system is automatically detected and distinguished during data output. The second TXD interface (pin 8) is not necessary.

Center Console Switch Cluster

The center console switch cluster is now split into two. For servicing, it must be noted that the performance electronics and the electrical system are integrated in a single module. Both modules are installed in the glove box device holder.